

TANK BAG

Accessory Name	Parts Number	Application Model	Issue Date	Publication No.	FRT
TANK BAG (3 L)	08L89-MKS-E00	XL750	2023.1	MII	0.2 H
CORD CLAMP	08E01-HAC-J00				

Introduction







ALL INFORMATION, ILLUSTRATIONS, DIRECTIONS AND SPECIFICATIONS INCLUDED IN THIS PUBLICATION ARE BASED ON THE LATEST PRODUCT INFORMATION AVAILABLE AT THE TIME OF APPROVAL FOR PRINTING. Honda Motor Co., Ltd. RESERVES THE RIGHT TO MAKE CHANGES AT ANY TIME WITHOUT NOTICE AND WITHOUT INCURRING ANY OBLIGATION WHATSOEVER. NO PART OF THIS PUBLICATION MAY BE REPRODUCED WITHOUT WRITTEN PERMISSION. THIS MANUAL IS WRITTEN FOR PERSONS WHO HAVE ACQUIRED BASIC KNOWLEDGE OF MAINTENANCE ON Honda MOTORCYCLES, MOTOR SCOOTERS OR ATVS.

Honda Dealer:
Please give a copy of these instructions to your customer.

Customer:
Because it requires specialized knowledge and special tools and equipment, it is recommended to install it at a dealer with qualified automobile maintenance.

How To Read These Symbols

Your safety, and the safety of others, is very important. To help you make informed decisions we have provided safety messages and other information throughout this manual.

-  **WARNING** You CAN be KILLED or SERIOUSLY HURT if you don't follow instructions.
-  **CAUTION** You CAN be HURT if you don't follow instructions.
-  **NOTICE** The purpose of this message is to help prevent damage to your vehicle, other property, or the environment.
-  **NOTE** Things you want to know, things that are useful to know.
-  Follow the instructions of the Service Manual.
-  Follow the other symbol instructions of the "Installation Instructions BASIC".

Instruction Other Symbols

The symbols used throughout this instructions show specific service procedures. Refer to "Installation Instructions BASIC" for description of each symbol.

INFORMATION

CAUTION

- To prevent burns, allow the engine, exhaust system, radiator, etc., to cool before installing the accessory.

NOTICE

- Take care not to damage the painted surfaces of the motorcycle.

NOTE:

- Heat the bonding surfaces with a hair dryer if the ambient air temperature is below 21°C (70°F).
- The adhesive reaches full strength in 72 hours. Wait at least 24 hours before riding your motorcycle.
- Before installation, remove all dust, sand, etc. from fuel tank and tank bag, as otherwise the fuel tank may be damaged.
- Save all removed parts unless otherwise indicated.

MAXIMUM LOADING CAPACITY

- The weight of the cargo must not exceed the following maximum loading capacity:

Maximum Loading Capacity	
Tank bag (3 L)	1.5 kg (3.3 lb)

PARTS LIST

When the instruction manual and installation instructions are included in this kit, be sure to give them to the customer.

<TANK BAG (3L)>

Component	No.	Parts Name	Qty	Parts No.
	(1)	Tank bag (3 L)	1	-
	(2)	Rain cover	1	-
	(3)	Protective film	2	-
	(4)	Collar	2	11533-MN5-300
	(5)	6 x 14 mm screw	2	90117-KPM-000
	(6)	Washer	2	94101-06700

<CORD CLAMP>

Component	No.	Parts Name	Qty	Parts No.
	(7)	Cord clamp	1	-

TORQUE INFORMATION

Refer to the Service Manual for the torque values including standard torque of the removed parts. (📖)

INSTALLATION

1. Refer to the Service Manual for the motorcycle, remove the motorcycle parts as shown. (📖)

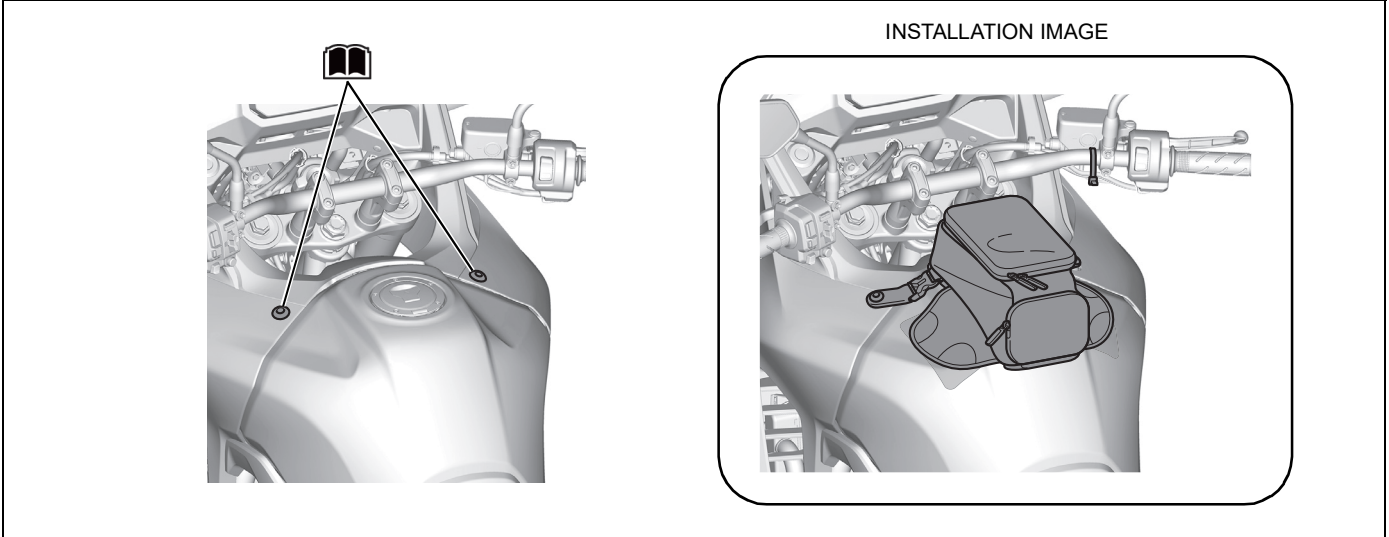

2. Cut the template along the dotted line and attach it to the protective film.

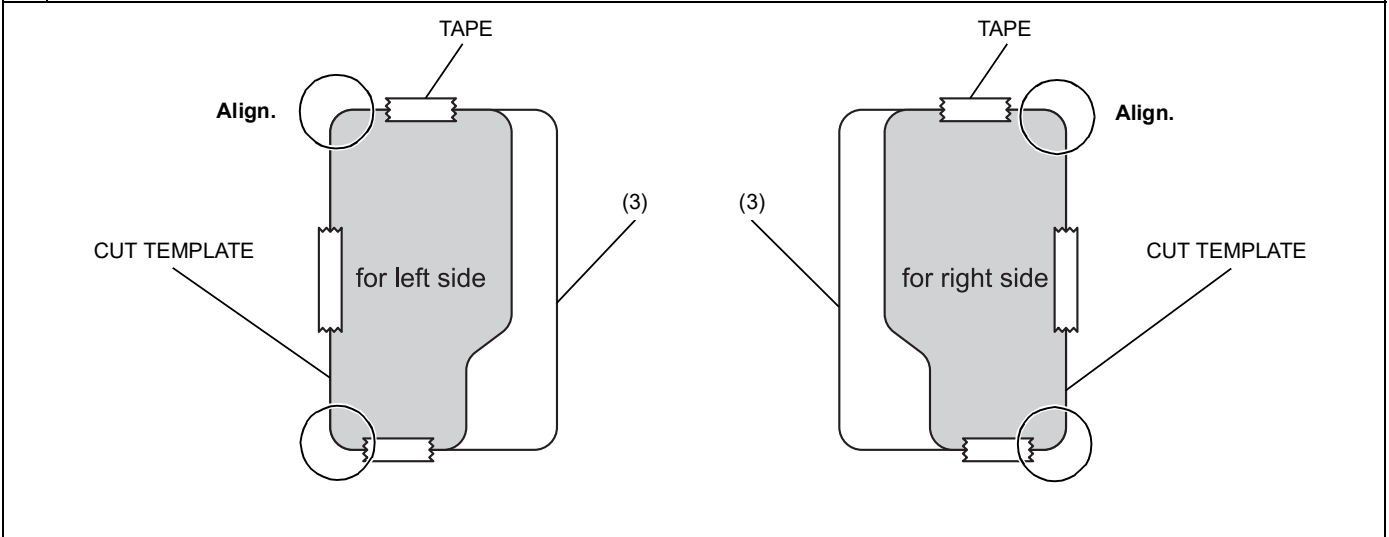

3. Cut the protective film along the template line as shown.

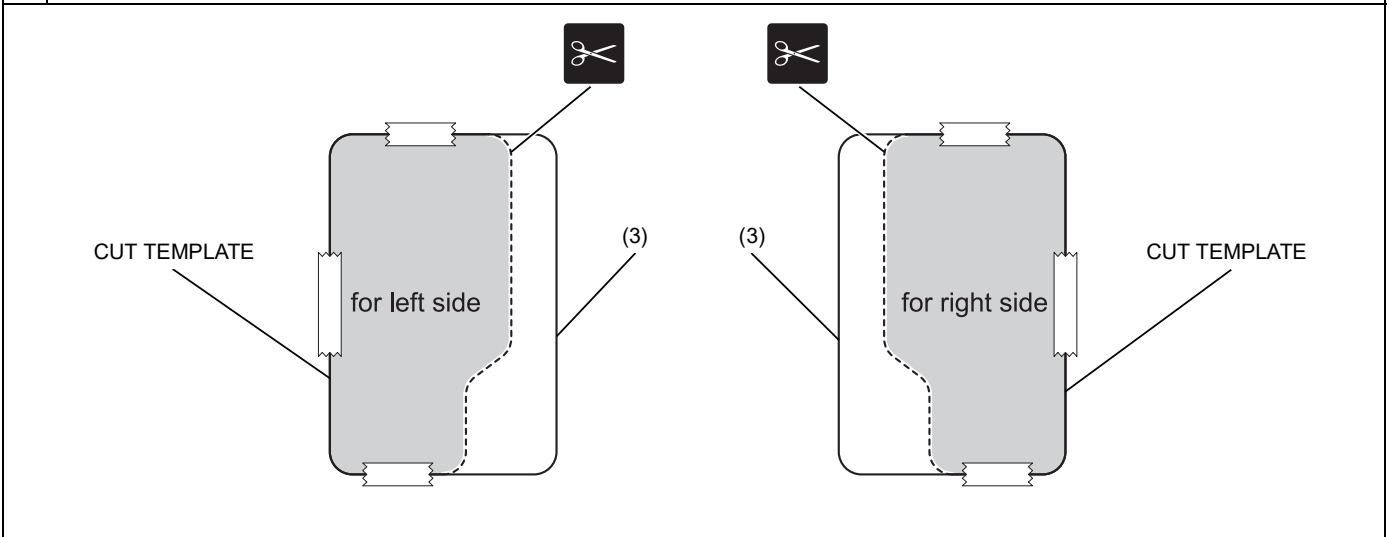

4. Install as shown.
• Repeat on the right side.

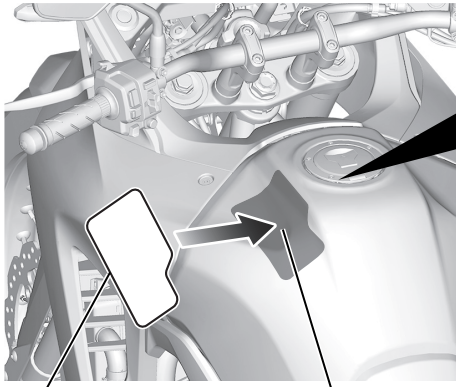

(3)
Remove the adhesive backing before attaching.



Attach the protective film as shown.

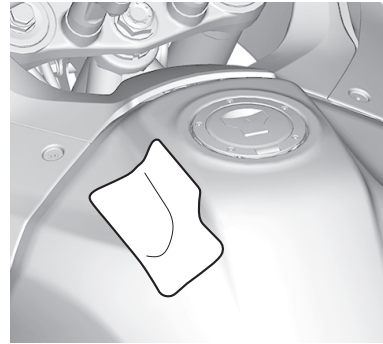

5. Install as shown.
• Repeat on the right side.

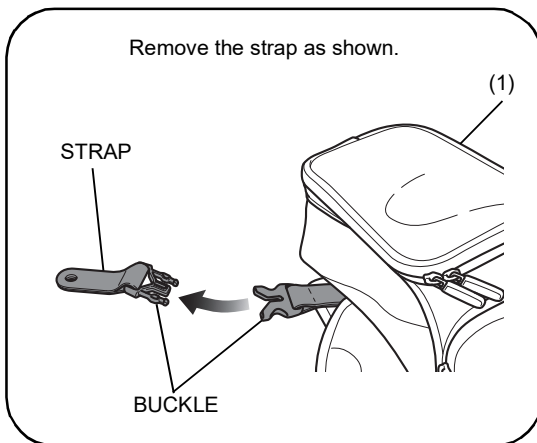

Remove the strap as shown.

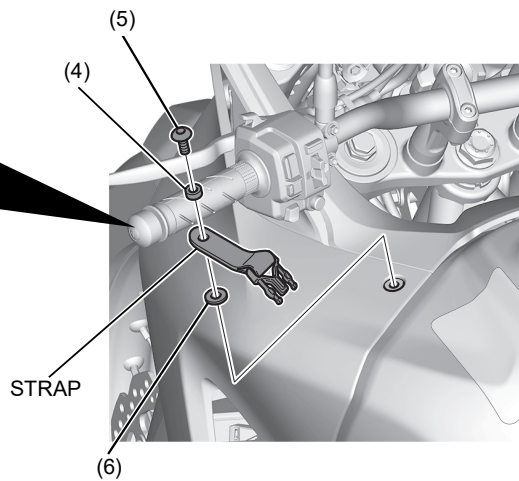

6. Install as shown.
• Repeat on the right side.

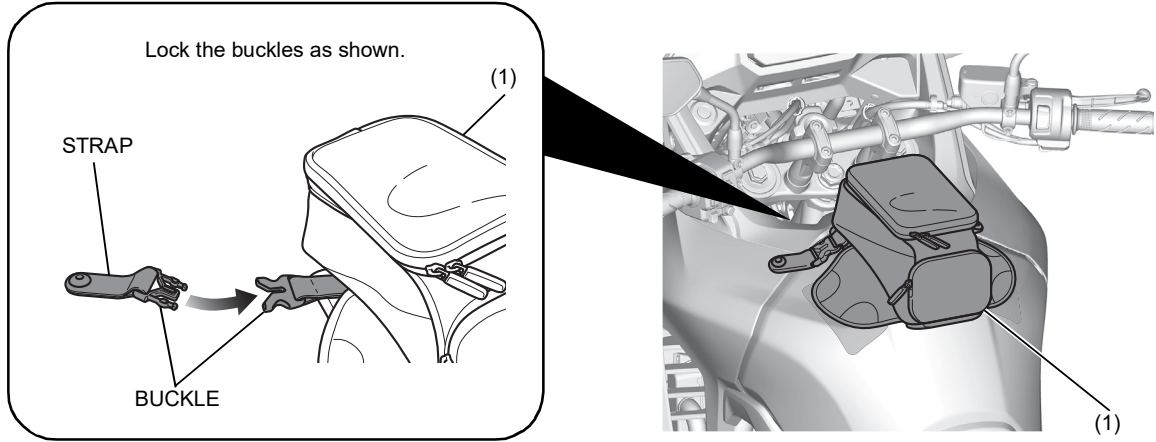

7. Install as shown.
• Move the handlebar right and left, and check that this accessory is not interfere with the motorcycle parts.

